

INSTALLATION INSTRUCTIONS

PEUGEOT 3008 5 DOOR

PEU-3008-5-A

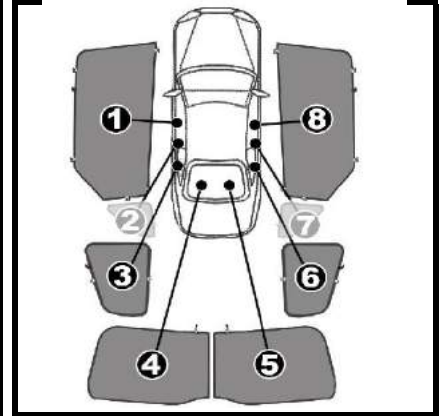

COMPONENTS INCLUDED

SHADES

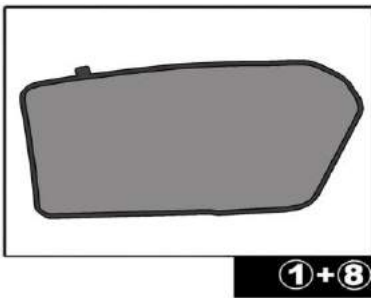

1+8

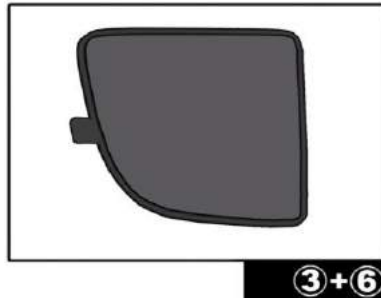

3+6

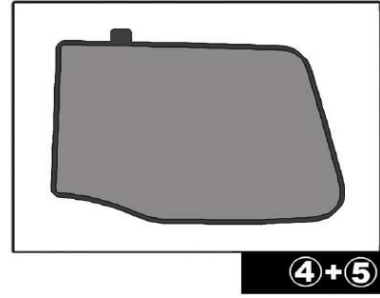

4+5

FIXING CLIPS



CL-M02 x8



CL-M011 x4

SIDE SHADE INSTALLATION

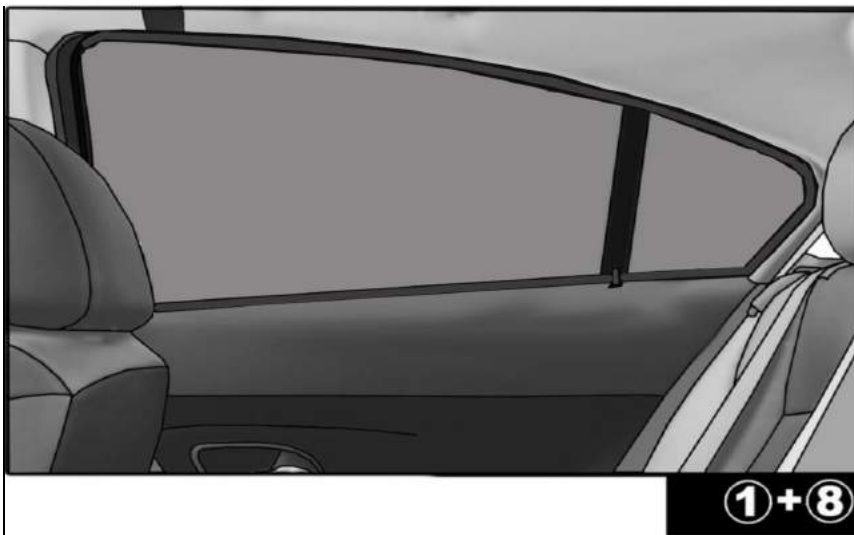
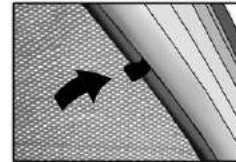
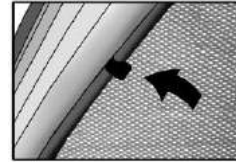
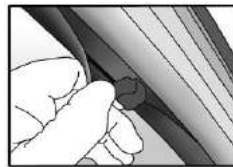
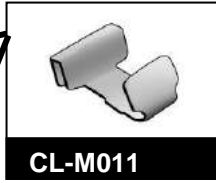
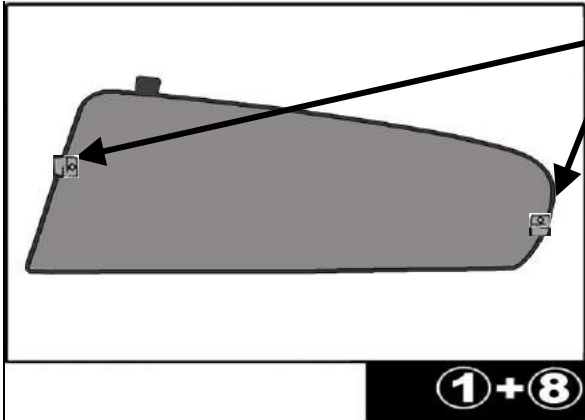

QUARTER LIGHT SHADE INSTALLATION

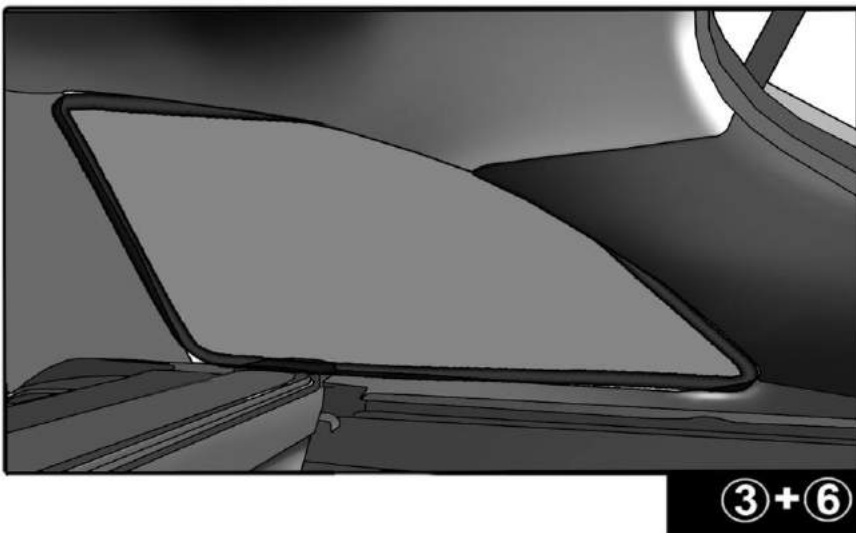
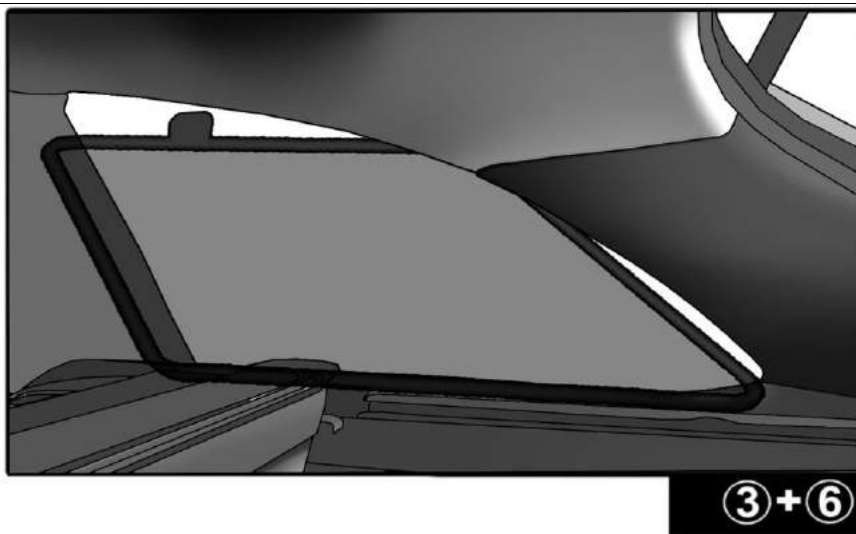
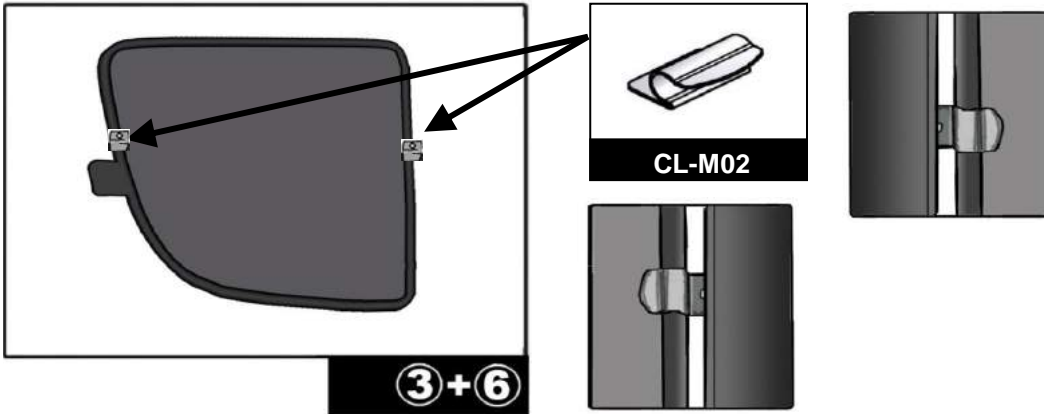

REAR SHADE INSTALLATION

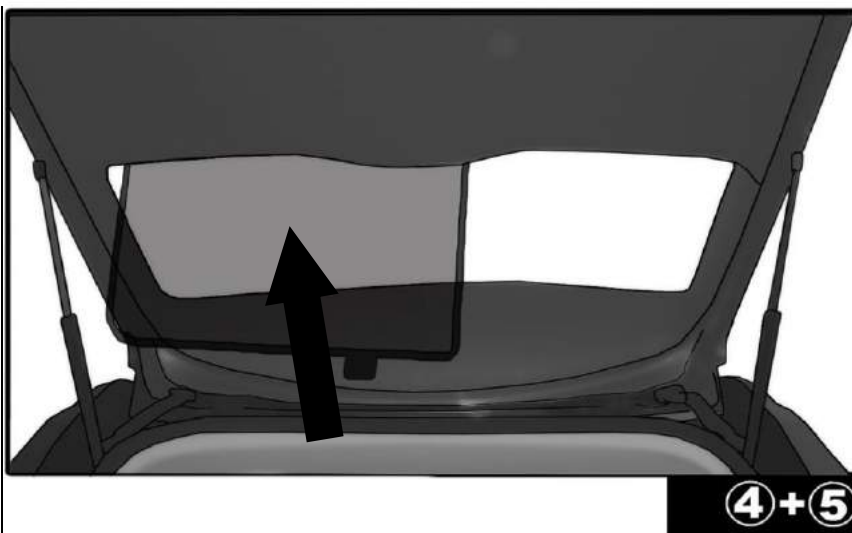
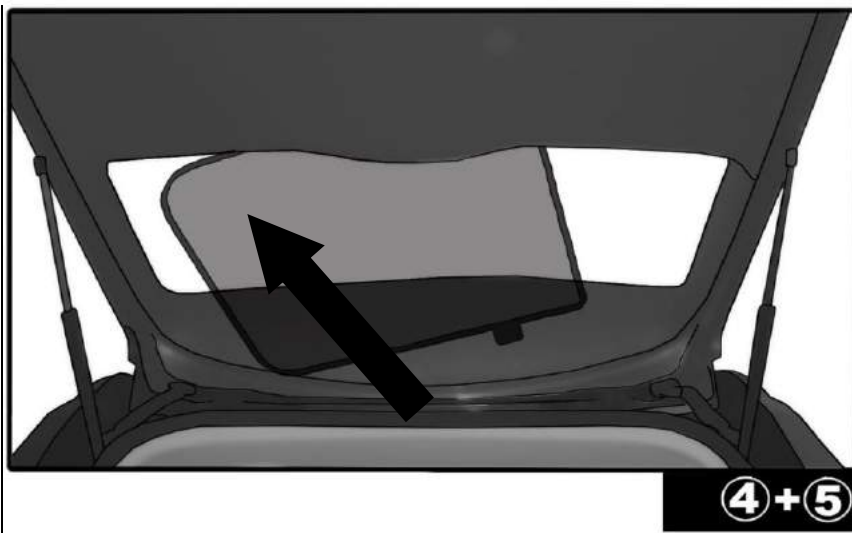
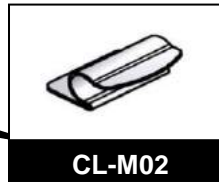
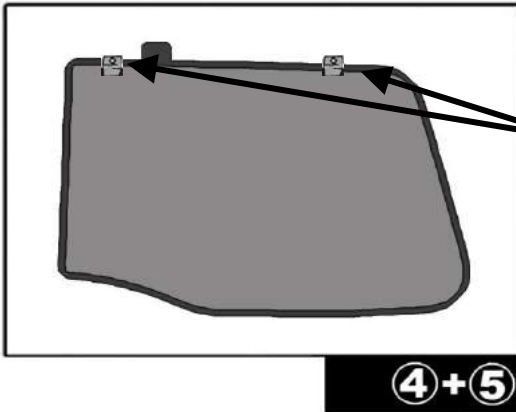

REAR SHADE INSTALLATION

