

# Installation Manual

HONDA CIVIC 4DR  
HON-CIVI-4-B

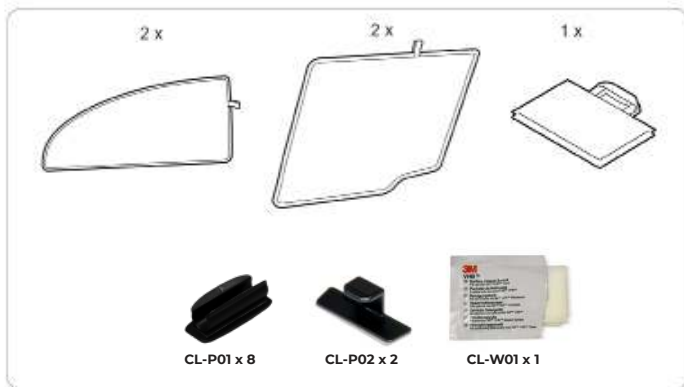

## COMPONENTS INCLUDED



# Installation

HONDA CIVIC 4DR

HON-CIVI-4-B



## CAUTION

- Do not move the rear door window glass during driving.

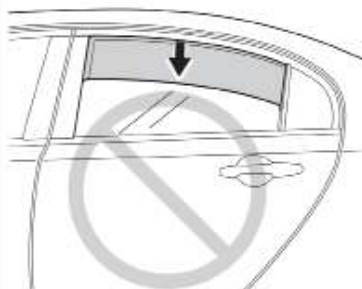

80275100

- The sunshade can come off unless it is installed on the clip securely.
- Sunshade must not be used during the hours of darkness.
- To allow the adhesive to "cure", do not install the sunshade for 24 hours; if not the clips will not reach their maximum adhesive strength and could be lost.

## TOOLS AND SUPPLIES REQUIRED

- Scale
- Felt-tip pen

## INSTALLATION

### Before You Begin:

- In these instructions, the illustrations show the left side sunshade being installed. The same procedure applies to the right side sunshade.
- This kit should only be installed if the ambient air temperature is 15°C (60°F) or above. Heat the bonding surfaces with a hair dryer set on LOW when the ambient air temperature is below 15°C (60°F).
- Before attaching the sunshades, thoroughly clean the bonding surfaces with a cleaner.
- Be extremely careful not to damage the body paint finish.

# Installation

HONDA CIVIC 4DR

HON-CIVI-4-B

## REAR DOOR

### Installing the Clip

1. Open the left rear door.
2. Check the positions where the clip are installed and clean the surfaces with the cleaner provided from the kit.

CLIP INSTALLATION POSITIONS (4)  
• Clean the surface with a cleaner.

LEFT REAR DOOR

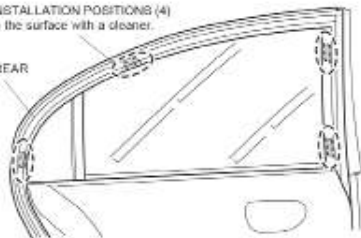

09270308

3. Measure each clip installation position to the dimensions shown.
4. Mark with a felt-tip pen the position of the measured dimension of the door sash.

Make marks as marks with felt-tip pen as shown.

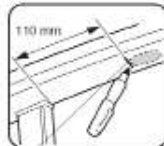

Make marks as marks with felt-tip pen as shown.

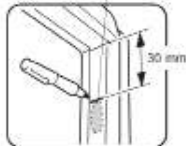

LEFT REAR DOOR SASH



Make marks as marks with felt-tip pen as shown.

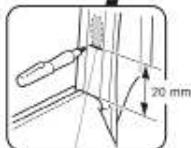

Make marks as marks with felt-tip pen as shown.

09270308

5. Remove the adhesive backing from each clip.
6. Align the edge of the clip with the mark on the door sash, and attach the clip on the sash.
  - Hold the adhesive tape of the clip back side firmly against the door sash for 15 seconds after attaching the clip.

Align the edge of the clip with the mark made in the step 4.

Align with the end of the radius.

Align the edge of the clip with the mark made in the step 4.



Align with the end of the radius.

DOOR GLASS

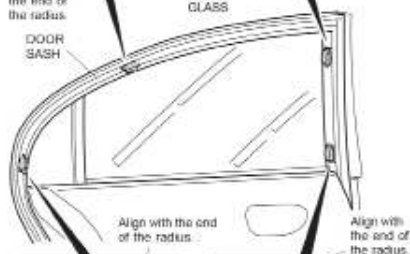

Align the edge of the clip with the mark made in the step 4.

DOOR GLASS

Align the edge of the clip with the mark made in the step 4.

09270405

7. Repeat the procedure to install the clip on the right side.

# Installation

HONDA CIVIC 4DR

HON-CIVI-4-B

## Installing the Side Sunshade

1. Install the sunshade on the clips in the numbered sequence of **1** through **4**.

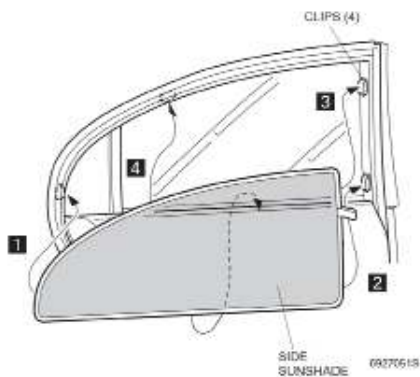

## Removing the Side Sunshade

1. Holding the strap, release the sunshade from the clips in the numbered sequence of **1** through **4**.

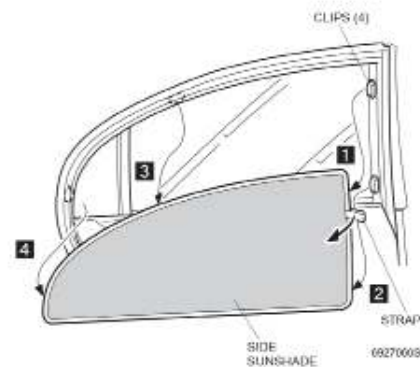

## REAR WINDOW

### Installing the Glass Clip

1. Check the positions where the clip are installed and clean the surfaces with the cleaner provided from the kit.



2. Measure each glass clip installation position to the dimensions shown.
3. Mark with a felt-tip pen the position of the measured dimension of the rear window.

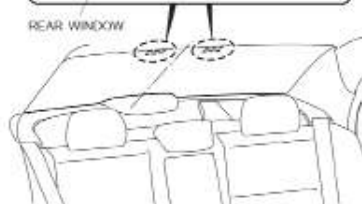
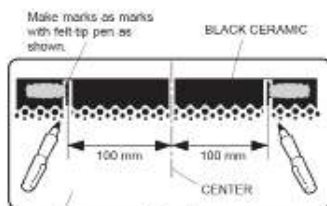

69270808

# Installation

HONDA CIVIC 4DR

HON-CIVI-4-B

4. Remove the adhesive backing from each glass clip.
5. Align the edge of the glass clip with the mark on the rear window, and attach the glass clip on the window.
  - Hold the adhesive tape of the glass clip back side firmly against the rear window for 15 seconds after attaching the glass clip.

Align the edge of the glass clip with the mark made in the step 3.

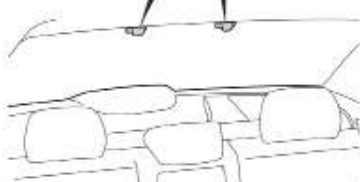
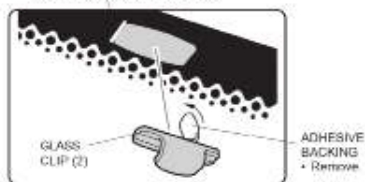

69270905

## Installing the Rear Sunshade

1. Install the sunshade on the glass clip **1**.
2. Secure the sunshade by setting it between the high mount brake light and rear window **2**.

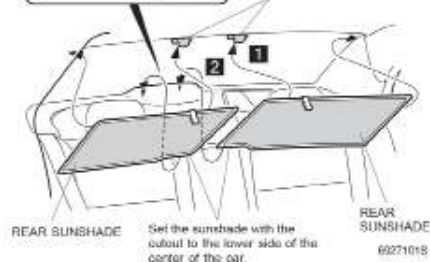

3. Install another rear sunshade.

## Removing the Rear Sunshade

1. Holding the strap **1**, release the sunshade from the glass clip.
2. Release the sunshade from the high mount brake light **2**.

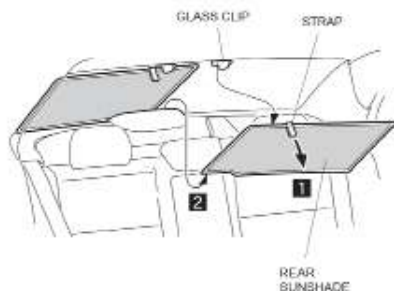

69271506

3. Remove another tailgate sunshade.



## ADVICE

After removing the sunshades, store them in a bag.